

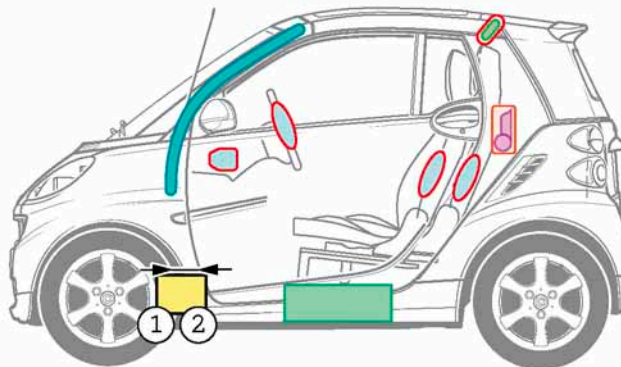

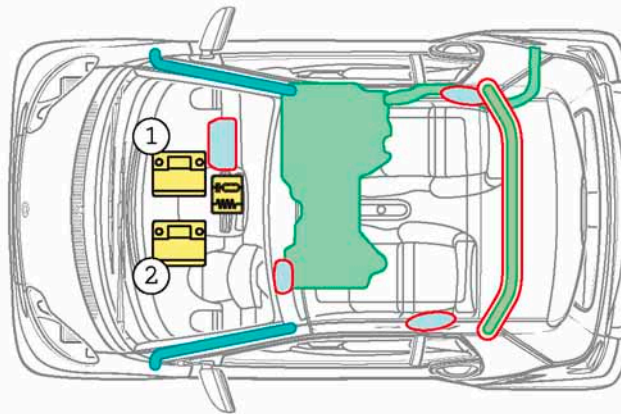





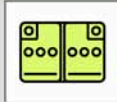

smart
fortwo
Cabriolet
Model 451

as of 2007

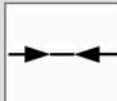

- 1 LHD vehicle
- 2 RHD vehicle

Legend

	Airbag		Structural reinforcements		Battery
	Gas generator		Rollover protection		High-voltage components
	Seat belt tensioner		Fuel tank		Cutting points
	Gas filled spring device		Control unit		